

TACTOSY FOR FEET

Feel the excitement of kicking a ball and the thrill when someone suddenly catches your foot.

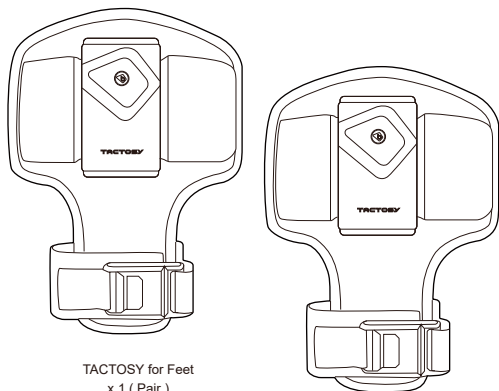

USB Type C Cable
x 2



Bluetooth Dongle
x 1



Manual
x 1



Tracker Connecting
Module x 2

Before Getting Started

Be sure to read the user manual before using the product to ensure safe and proper use of the product.

- Please read the bHaptics Limited Warranty before using the product. (www.bhaptics.com/legal)
- Do not use the product for any purpose other than the intended purpose.
- Do not attempt to modify, disassemble or repair the product.
- Do not drop the product or subject the product to other forms of strong impact.
- Users with sensitive skin should not wear the product directly on their skin.
- Excessive pulling on the main strap while wearing the product may irritate the user's skin.
- This product is not waterproof. Store the product in a dry place, free from humidity and moisture.
- The product contains electronic components and must not be washed in water under any circumstances. The inner lining may be removed and lightly washed with a mild laundry detergent. (Although machine washing the lining is allowed, do not use strong chemicals or detergents, such as chlorine and bleach).
- The most up-to-date user manual for the device and related software can be found at www.bhaptics.com/support

Overview

Front

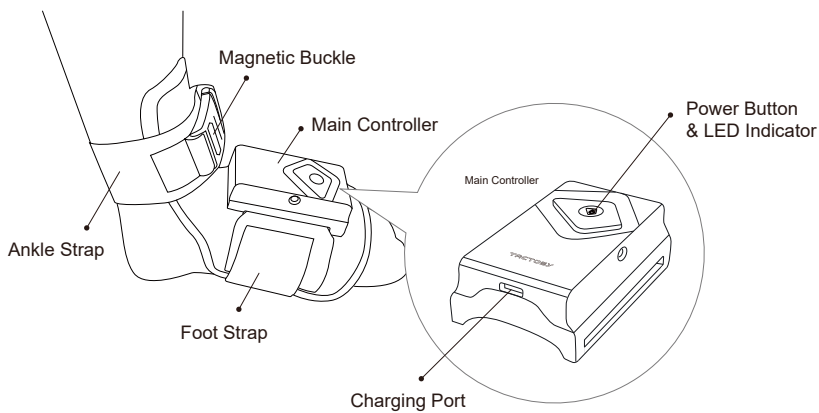

Back

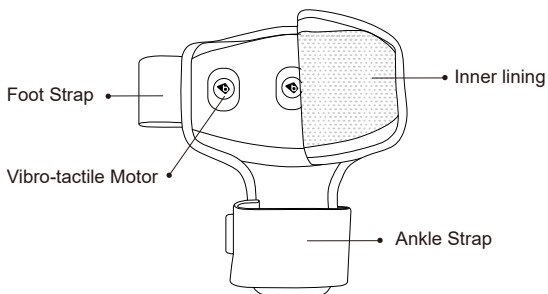

Putting on

Please follow the instructions below and wear the device tight around your foot in order to feel haptic feedback effectively.

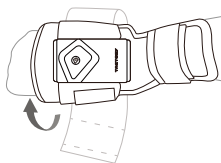

- STEP 01** Place the device on top of your foot. Securely wrap the foot strap around your foot and fasten with Velcro.

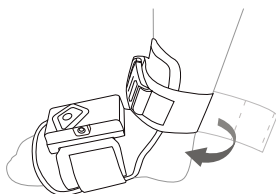

- STEP 02** Wrap the ankle strap around your ankle and fasten with Velcro. Fasten it one more time using the magnetic buckle.



*Magnetic buckle connection

- 
- 
- 

- STEP 03** After wearing the device, use it like below.

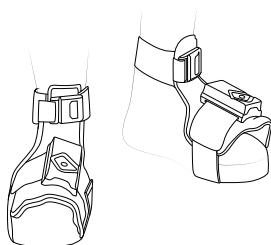

*Vive Trackers are not included

If necessary, you can attach a VIVE tracker to the device and use them together.



- Fasten a VIVE Tracker to connection module using the provide rubber washer and wing screw. Make sure the holes on the tracker and connection module are aligned before fastening them together.
- Place the module from Step 1 on top of the main controller of the device and fasten them together with wrench bolts.



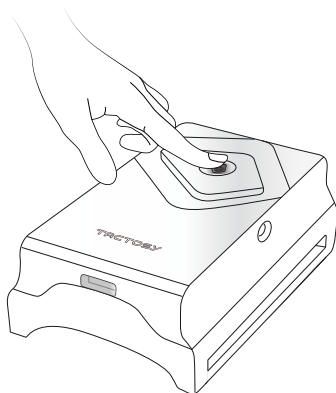

How to Use

Power On

Click the power button on the main controller, then the LED status indicator will blink blue as it waits for pairing.



LED Color Indication

LED color	BLE status
 Blinking Blue	Power on / Waiting for pairing
 Solid Red	Lack of Battery/ Charging
 Solid Green	Paired (Right)
 Solid Blue	Paired (Left)
 No Light While Plugged in	Fully Charged

How to play

PC / PCVR

01 Install bHaptics Player from

www.bhaptics.com/download



- ▲ Download the correct version of the bHaptics Player for your Windows OS version. Installing improper SW may result in an error.

02 Pairing

Open the bHaptics Player and pair the device to your PC.

Right click the device icon on the bHaptics Player and click "Pair" button.

Once paired, the device icon on the bHaptics Player and LED indicator of the device will turn blue for the left and green for the right.

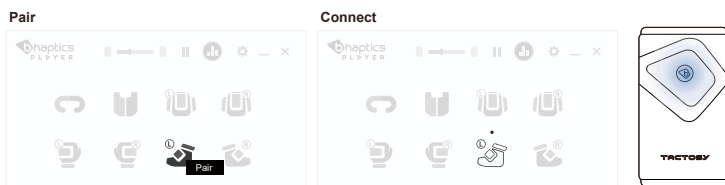

- ▲ Do NOT try pairing on Windows Bluetooth & Other Devices Settings.

03 Enjoy

• Embedded Haptic Feedback

Play Content with Native Support

- Games with native support are embedded with optimized haptic feedback for each in-game event. The Game list is available at www.bhaptics.com/games

▲ Not all of the games listed in the compatible game list (bhaptics.com/games) support Tactosy for Feet

• Automatically Generated Haptic Feedback

Use Audio to Haptic Function

- When playing games that do not provide native support for TactSuit, try out the Audio-to-Haptic function. You can enjoy automatically generated real-time haptic feedback based on audio signal of games.



▲ When playing natively supported content, make sure Audio-to-Haptic is turned off.

Standalone VR

• Play Content with Native Support

- Pairing method for Standalone VR games varies from game to game. Please contact game developer for how to pair TactSuit in each game. The game list is available at www.bhaptics.com/games.

▲ Not all of the games listed in the compatible game list (bhaptics.com/games) support Tactosy for Feet

* Audio-to-Haptic function is currently not supported on Standalone VR HMDs.

Device Specification

Product Name	<i>TACTOSY for Feet</i>
Model Name	<i>BHTTS0300</i>
Main Functions	<i>Replicate and deliver stimulation through haptic feedback</i>
Feedback Point	<i>Total: 6 points (3 for each foot)</i>
Size	<i>Free Size</i>
Weight	<i>260g</i>
Operation Time	<i>36.7 hours (When all feedback points are operating for 1sec in every 5sec at maximum intensity)</i>
Operation Temperature	<i>-5 - 40 °C</i>
Operational Relative Humidity	<i>From 5% to approx. 90%</i>
Wireless Frequency	<i>2.402 - 2.480 GHz (Bluetooth LE)</i>
Peak Output Power (RF)	<i>0.13 mW</i>
Connection type	<i>Bluetooth Low Energy (BLE)</i>
Battery	<i>3.8V, 2900mAh, 11Wh</i>
Charging type	<i>5V, 2A max</i>



bHaptics Limited Warranty
Health and Safety Warnings

www.bhaptics.com/legal

Trademarks

- TACTSUIT, TACTSUIT logo, bHaptics, bHaptics logo and all other product and services names of bHaptics are registered trademarks of bHaptics Inc.
- All company/product/service names, trademarks are copyright material of their respective owners. And use of those trademarks in this document doesn't mean affiliation, cooperation or endorsement with bHaptics Inc.
- Not all marks are used in this manual.

Copyright

- This manual is protected under international copyright laws. Any part of this user manual is permitted to reproduce, translate, distribute or transmit in any form or by any means, including photocopying, recording, or other electronic or mechanical methods, without the prior written permission of bHaptics Inc.

Any Questions?

contact@bhaptics.com

© 2020 bhaptics.Inc All rights reserved

